

MD – 60 / 95 / 100 / 180 – PN...

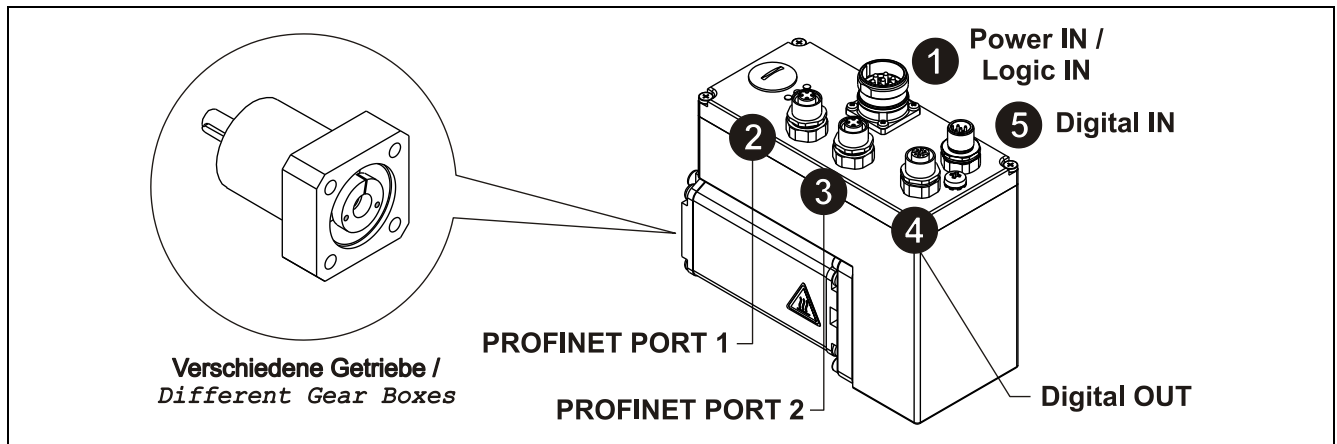

Steckseite / Mating Face

1   Stift / Male Connector (CONINVERS M23)		
1	0 V	Power IN
<sup>2)</sup> 2	0 V	Logic IN (Digital IN / Digital OUT / Electronic)
<sup>1)</sup> 3	+24 V DC	
4 – 5	N.C.	–
6	PE	Erdung / Protective earth conductor
7	+24 V DC	Power IN

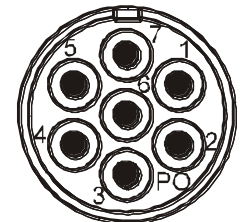

2   PORT 1 Flanschdose / Female Connector (M12x1-4 pol.)		
1	TxD+, Sendedaten +	PROFINET
2	RxD+, Empfangsdaten +	
3	TxD-, Sendedaten –	
4	RxD-, Empfangsdaten –	

D-coded

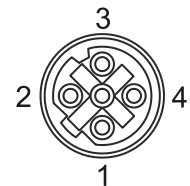

3   PORT 2 Flanschdose / Female Connector (M12x1-4 pol.)		
1	TxD+, Sendedaten +	PROFINET
2	RxD+, Empfangsdaten +	
3	TxD-, Sendedaten –	
4	RxD-, Empfangsdaten –	

D-coded

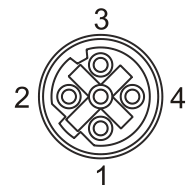

4   Flanschdose / Female Connector (M12 x 1-5 pol.)		
<sup>2)</sup> 1	<sup>3)</sup> 0 V (OUT)	Digital OUT
2	Output 0, ≤ 0,3 A	
3	Output 1, ≤ 0,3 A	
4	Output 2, ≤ 0,3 A	
5	Output 3, ≤ 0,3 A	

A-coded

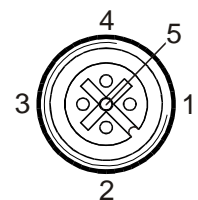

5   Flanschstecker / Male Connector (M12 x 1-5 pol.)		
<sup>1)</sup> 1	<sup>3)</sup> +24 V DC (OUT)	Digital IN
2	Input 0	
3	Input 1	
4	Input 2	
5	Input 3	

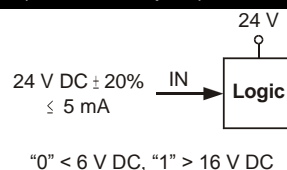

A-coded

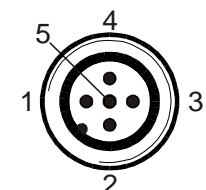

<sup>1)</sup> <sup>2)</sup> intern jeweils miteinander verbunden / internally connected with each other

<sup>3)</sup> Max. Ausgangsstrom: ≤ 1 A ! / Max. output current: ≤ 1 A !

**Interface IEEE-1394 / PROFINET Status LEDs**

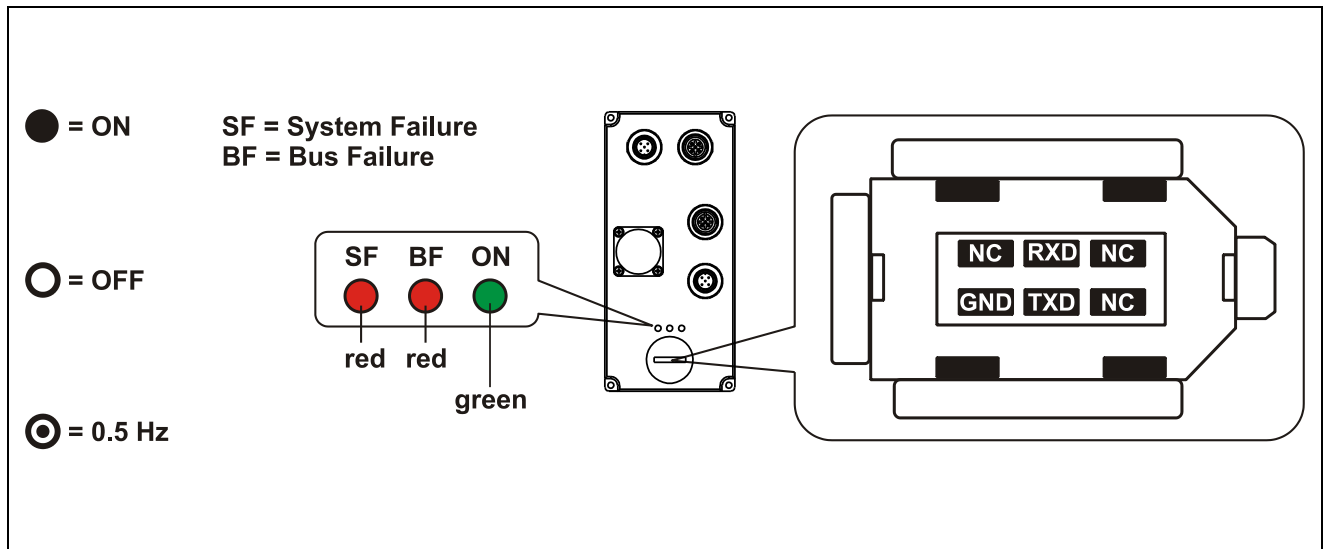

SF	BF	ON	Bedeutung	Ursache	Meaning	Cause
○	○	○	Keine Spannungsversorgung	- Spannungsversorgung unterbrochen - Spannungsversorgung verpolt	No Power	- Voltage supply interrupted - Voltage supply reversed
●	●	●	Keine PROFINET-Kommunikation	- Bus unterbrochen - Keine Verbindung zu einem IO-Controller - Falscher Gerätename	No PROFINET connection	- Bus disconnected - No connection to an IO-Controller - Wrong device name
●	⊙	●	Parametrierungsfehler PROFINET	- Prozessdatenkonfiguration ≠ gesteckte RT-Module im IO-Controller	PROFINET Parameterization fault	- Process data configuration ≠ plugged RT-modules into IO-Controller
●	○	●	Störung vorhanden	- Störungsursache gemäß Parameter P947	Failure occurred	- Trouble source according to parameter P947
⊙	⊙	●	PROFINET Blinken	- vom IO-Controller initiiertes Blinken zur manuellen Lokalisierung des IO-Devices	PROFINET Flashing	- from the IO-Controller initiated flashing to locate the IO-Device
○	○	●	PROFINET-Kommunikation und Antrieb OK	-	PROFINET Communication and drive OK	-