

## Steckerbelegung / Pin assignment

### MD-300-PB-... (3x Digital IN)

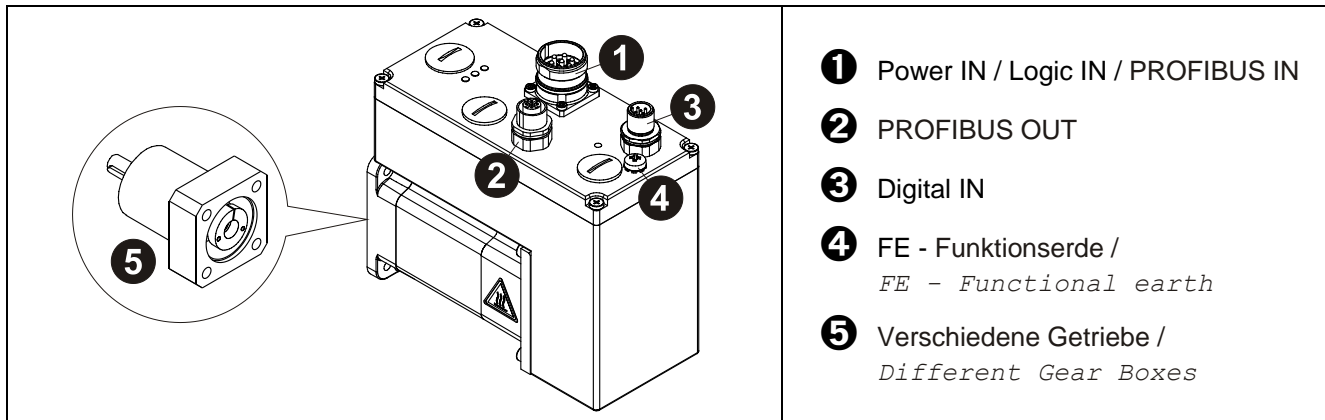

Die Schirmung ist großflächig auf das Gegensteckergehäuse aufzulegen!  
 Empfehlung: Potentialausgleich (FE) groß-flächig mit dem Erdungsanschluss der Anlage verbinden. /



*The shielding is to be connected with large surface on the mating connector housing!*

*Recommendation: Connect the potential equalisation (FE) to the grounding connection of the system across a sufficiently sized surface.*

Steckseite / Mating Face

1	Stift / Male Connector (CONINVERS M23)	
1	0 V	Power IN
<sup>2)</sup> 2	0 V	Logic IN (Digital IN / Electronic)
<sup>1)</sup> 3	+24 V DC	
4	Profibus, Data A	PROFIBUS IN
5	Profibus, Data B	
6	N.C.	-
7	+24 V DC	Power IN

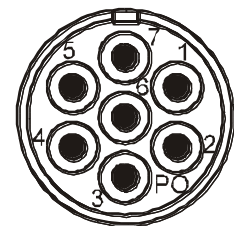

2	Buchse / Female Connector (M12 x 1-5 pin)	
1	N.C.	PROFIBUS OUT
2	Profibus, Data A	
3	N.C.	
4	Profibus, Data B	
5	N.C.	
Gewinde / Thread	Shield	

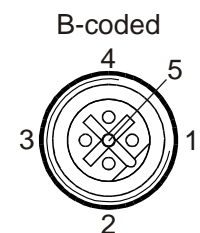

3	Stift / Male Connector (M12 x 1-5 pin)	
<sup>1)</sup> 1	+24 V DC (OUT)	Digital IN $24\text{ V DC} \pm 20\%$ $\leq 5\text{ mA}$ $"0" < 6\text{ V DC}, "1" > 16\text{ V DC}$
<sup>2)</sup> 2	0 V (OUT)	
3	Input 0	
4	Input 1	
5	Input 2	

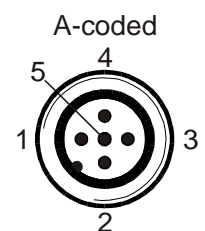
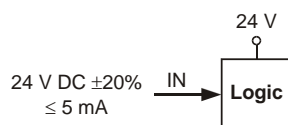

<sup>1) 2)</sup> intern jeweils miteinander verbunden / internally connected with each other  
**max. Ausgangsstrom: ≤ 1 A ! / Max. output current: ≤ 1 A !**

## Steckerbelegung / Pin assignment

### Profibus-Adresse, Busabschluss / Profibus Address, Bus Termination

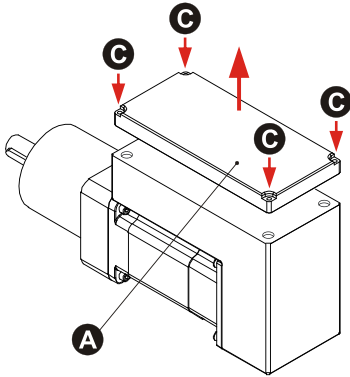

Schrauben (C) lösen und Deckel (A) abheben

*Loosen the screws (C) and take off the cover (A)*

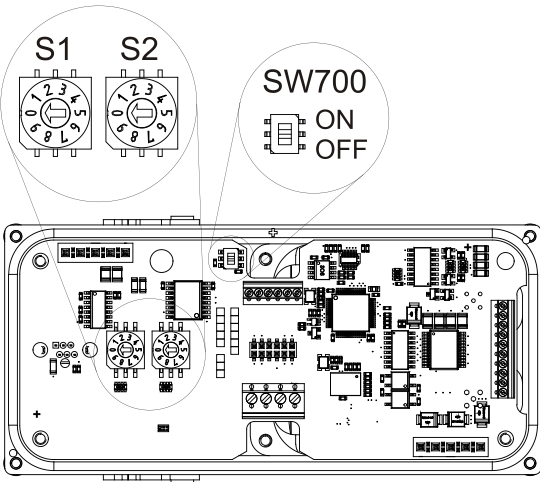

- Über die Adress-Schalter S1 und S2 auf der Deckelunterseite (A) die Profibus-Adresse einstellen. S1 = 10<sup>1</sup> / S2 = 10<sup>0</sup>. Gültige Profibus-Adressen = 3 - 99.
- Einschaltung des Abschluss-Widerstandes über SW700, wenn das Gerät der erste oder letzte Teilnehmer in der Bus-Linie ist. Der abgehende Bus wird dabei unterbrochen.

*Adjust the Profibus address via the address switches S1 and S2 on the cover bottom side (A). S1 = 10<sup>1</sup> / S2 = 10<sup>0</sup>. Valid Profibus addresses = 3 - 99.*

*Switching-on of the terminal resistance via SW700, if the device is the first or last subscriber in the bus line. Thereby, the outgoing bus is interrupted.*

### Interface IEEE-1394 / PROFIBUS Status LEDs

● = ON

○ = OFF

⊙ = 0.5 Hz

SF    BF    ON

rot / red    grün / green

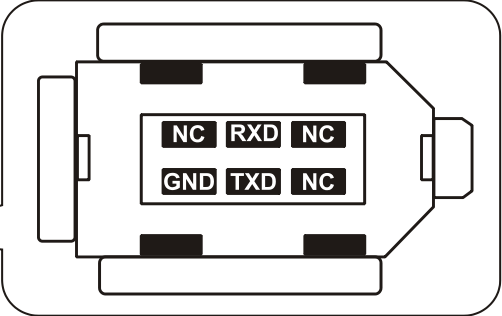

SF	BF	ON	Bedeutung	Ursache	Meaning	Cause
○	○	○	Keine Spannungsversorgung	-	No power	-
●, ○	●	●	Keine Verbindung zu einem Gerät - kein Data Exchange	- Bus unterbrochen - Master nicht verfügbar/abgeschaltet	No connection to another device -no Data Exchange	-Bus disconnected -Master not available / switched off
●, ○	⊙	●	Parametrierungsfehler - Data Exchange korrekt. Slave jedoch nicht im Data Exchange Mode	- Slave nicht oder falsch konfiguriert - Falsche Stationsadresse - Akt. Konfiguration ≠ Sollkonfiguration	Parameterization fault, no Data Exch. -Data Exchange correct. However, the slave is not in Data Exchange mode	-Slave not or wrong configured -Wrong station address assigned -Act. Configuration ≠ Nominal Config.
●	○	●	Fehler innerhalb des Slaves - Slave im Data Exchange Mode	- Min. 1 Slave-Diagnose-Meldung - Ungültige Stationsadresse	Fault within slave -Slave in Data Exchange mode	-Min. 1 slave-diagnosis-message -Improper station address assigned
○	○	●	Data Exchange. Slave und Betrieb OK	-	Data Exchange. Slave + operation OK	-