

M12 St. 0° / M12 St. 0° geschirmt, Ethernet

PUR 2x2xAWG22 geschirmt gn UL,CSA+schleppk. 5m

Ethernet CAT5e

Stecker gerade – Stecker gerade

M12 – M12, 4-polig

D-kodiert

geschirmt

Übertragungseigenschaften bei Channel Übertragung bis 100 m

Abweichende Leitungslängen auf Anfrage lieferbar. Das Material der Gehäuse ist aus Kunststoff und hat eine gute Chemikalien- und Ölbeständigkeit. Beim Einsatz aggressiver Medien ist die Materialbeständigkeit applikationsbezogen zu überprüfen. Nähere Details auf Anfrage.

[Link zum Produkt](#)

Abbildungen

stay connected



Abbildung stellvertretend

Zulassungen

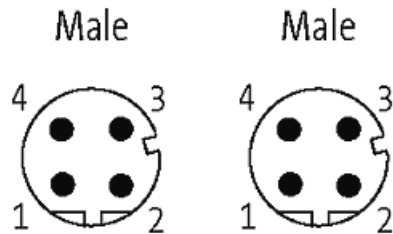
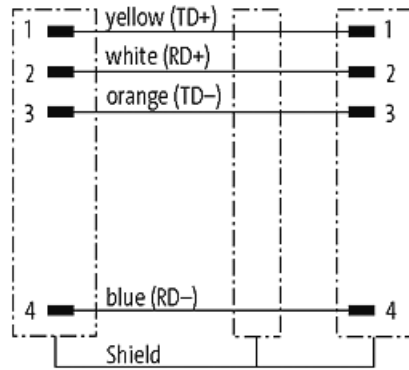
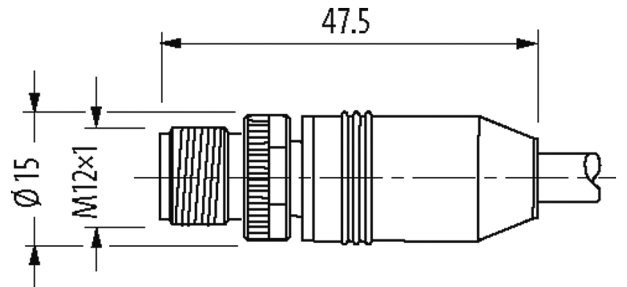
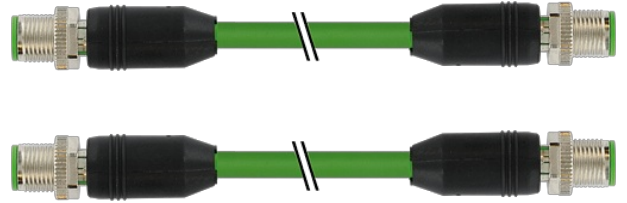

* nur für Produkte mit UL/CSA-zugelassener Leitung

cCSAus

Bustechnologien



Bauform

Bauform

44511

Leitungen

Adernzahl/-querschnitt	2× 2× 0.34 mm ²
Aderisolation	PE (ws, ge, bl, or)
Schleppkettenwerte	3 Mio.
Mantelfarbe	grün
Material (Mantel)	PUR (UL/CSA)
Außen-Ø	6.7 mm ±5%
Biegeradius (bewegt)	12× Außen-Ø
Temperaturbereich (fest)	-40...+80 °C
Temperaturbereich (bewegt)	-30...+70 °C
Kabelkennung	796
Zulassung (Kabel)	UL (AWM-Style 20233/11602), CSA; CE
Kabelgewicht [g/m]	71
Material (Leiter)	Cu-Litze, blank
Widerstand (Leiter)	max. 55 Ω/km (20 °C)
Querschnitt (Leiter)	2× 2× AWG22
Material (Aderisolation)	PE
Ader-Ø inkl. Isolierung	1.4 mm ±5%
Adernfarbe/Nummerierung	ws, ge, bl, or
Verseilverbund	Sternvierer, 4 Adern über zentralen Füller verseilt
Schirmung	ja
Schirmung (Art)	Kupfergeflecht
optische Schirmbedeckung	min. 85%
Material (Mantel)	PUR
Außen-Ø (Mantel)	6.7 mm ±5%
Farbe (Mantel)	grün
thermische Beständigkeit	flammwidrig
Nennspannung	300 V
Temperaturbereich (fest)	-40...+80 °C
Temperaturbereich (bewegt)	-30...+70 °C
Biegeradius (fest)	5× Außen-Ø
Biegeradius (bewegt)	12× Außen-Ø
Anzahl Biegezyklen (Schleppkette)	max. 3 Mio. (25 °C)
Verfahrweg (Schleppkette)	max. 5 m (horizontal)
Verfahrgeschwindigkeit (Schleppkette)	max. 3.3 m/s
Beschleunigung (Schleppkette)	max. 2 m/s ²

Technische Daten

Betriebsspannung	max. 60 V DC
Betriebsspannung (nur UL-listed)	max. 30 V DC
Bemessungsstoßspannung	1.5 kV
Betriebsstrom je Kontakt	max. 4 A
Isolierstoffgruppe	IEC 60664-1, category I
Übertragungsparameter	CAT5e, Class D (ISO/IEC 11801:2002), (EN 50173-1)
Übertragungsrate	bis 100 Mbit/s full duplex
Kodierung	D-kodiert
Verriegelung der Steckplätze	Schraubgewinde (M12×1 mm) empf. Anzugsdrehmoment 0.6 Nm, selbstsichernd
Verschraubung	M12 (SW13)
Schutzart	IP65, IP66K, IP67 in gestecktem und verschraubtem Zustand (EN 60529)
Material (Verriegelung)	Zink-Druckguss, matt vernickelt
Material	PUR
passend für Wellenschlauch (Innen-Ø)	ohne

Allgemeine Daten

Normen	DIN EN 61076-2-101 (M12)
Verschmutzungsgrad	3
Befestigungsart	gesteckt, verschraubt
Temperaturbereich	-25...+85 °C, abhängig von angeschlossener Leitung

Kaufmännische Daten

EAN	4048879141307
eClass	27061801
Ursprungsland	HU
Verpackungseinheit	1
Zolltarifnummer	85444290

M12 male 0° / M12 male, 0°, shielded, Ethernet

PUR 2x2xAWG22 shielded gn UL,CSA+dragchain 5m

Ethernet CAT5e

Male straight – male straight

M12 – M12, 4-pole

D-coded

shielded

Further cable lengths on request. Plastic housings with good resistance against chemicals and oils. The resistance to aggressive media should be individually tested for your application. Further details on request.

[Link to Product](#)

Illustration

stay connected

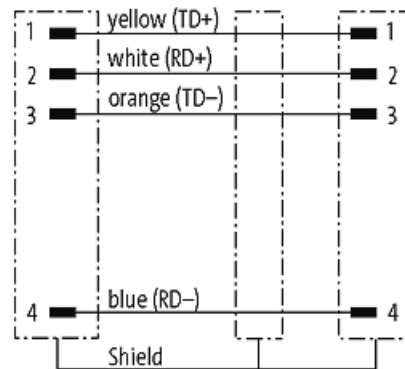
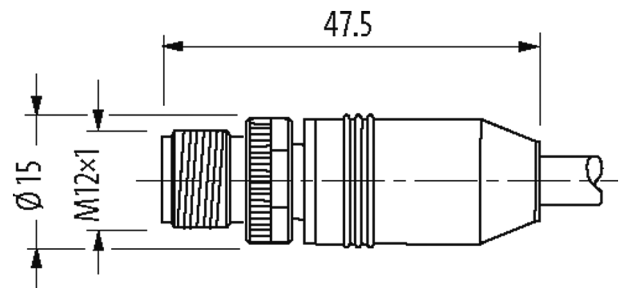
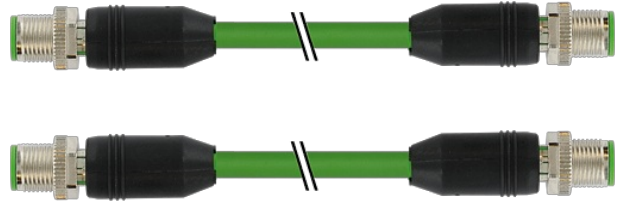

Male

Male



Product may differ from Image

Approvals



* only for products with UL/CSA approved cable

cCSAus

More Info



Form

Form

44511

Cables

No./diameter of wires	2× 2× 0.34 mm ²
Wire isolation	PE (wh, ye, bl, or)
C-track properties	3 Mio.
Jacket Color	green
Material (jacket)	PUR (UL/CSA)
Outer Ø	6.7 mm ±5%
Bend radius (moving)	12× outer Ø
Temperature range (fixed)	-40...+80 °C
Temperature range (mobile)	-30...+70 °C
Cable identification	796
Approval (cable)	UL (AWM-Style 20233/11602), CSA; CE
Cable weight [g/m]	71
Material (wire)	Cu wire, bare
Resistor (core)	max. 55 Ω/km (20 °C)
Diameter (core)	2× 2× AWG22
Material (wire isolation)	PE
Wire-Ø incl. isolation	1.4 mm ±5%
Color/numbering of wires	wh, ye, bl, or
Shield	yes
	min. 85%
Material (jacket)	PUR
Outer-Ø (jacket)	6.7 mm ±5%
Color (jacket)	green
thermal resistance	flame retardant
Nominal voltage	300 V
Temperature range (fixed)	-40...+80 °C
Temperature range (mobile)	-30...+70 °C
Bend radius (fixed)	5× outer Ø
Bend radius (moving)	12× outer Ø
No. of bending cycles (C-track)	max. 3 Mio. (25 °C)
Traversing distance (C-track)	max. 5 m (horizontal)
Travel speed (C-track)	max. 3.3 m/s
Acceleration (C-track)	max. 2 m/s ²

Technical Data

Operating voltage	max. 60 V DC
Operating voltage (only UL listed)	max. 30 V DC
Rated surge voltage	1.5 kV
Operating current per contact	max. 4 A
Material group	IEC 60664-1, category I
Transfer parameters	CAT5e, Class D (ISO/IEC 11801:2002), (EN 50173-1)
Transfer rate	up to 100 Mbit/s full duplex
Coding	D-coded
Locking of ports	Screw thread (M12×1 mm) recommended torque 0.6 Nm, self-securing
Compression gland	M12 (SW13)
Protection	IP65, IP66K, IP67 inserted and tightened (EN 60529)
Locking material	Zinc die casting, matte nickel plated
Material	PUR
suitable for corrugated tube (internal Ø)	without

General data

Standards	DIN EN 61076-2-101 (M12)
-----------	--------------------------

Pollution Degree	3
Mounting method	inserted, tightened
Temperature range	-25...+85 °C, depending on cable quality

Commercial data

country of origin	HU
customs tariff number	85444290
EAN	4048879141307
eClass	27061801
Packaging unit	1