

M12 St. 0° / RJ45 St. 0° geschirmt, Ethernet

PUR 2x2xAWG22 geschirmt gn UL,CSA+schleppk. 5m

Stecker gerade – Stecker gerade

M12 – RJ45, 4-polig

D-kodiert

geschirmt

Ethernet CAT5

Abweichende Leitungslängen auf Anfrage lieferbar. Das Material der Gehäuse ist aus Kunststoff und hat eine gute Chemikalien- und Ölbeständigkeit. Beim Einsatz aggressiver Medien ist die Materialbeständigkeit applikationsbezogen zu überprüfen. Nähere Details auf Anfrage.

[Link zum Produkt](#)

Abbildungen

stay connected

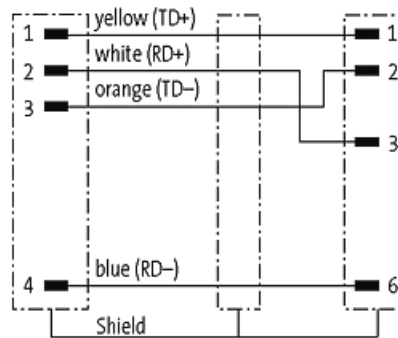
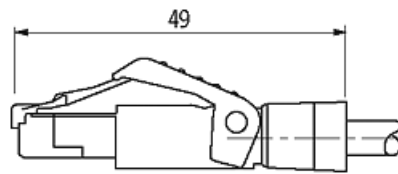
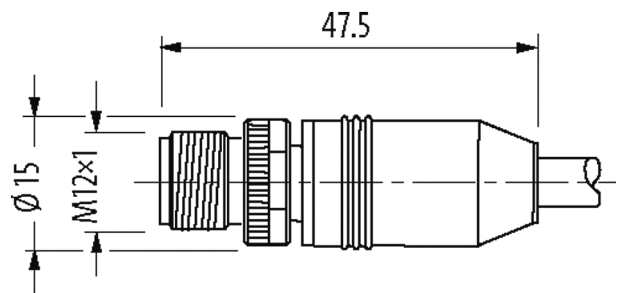
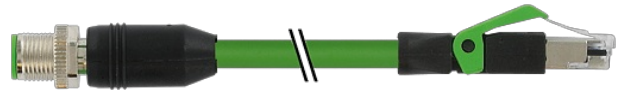

Male

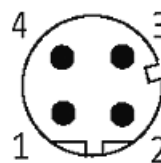

Male



Abbildung stellvertretend

Zulassungen

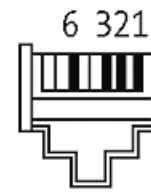

* nur für Produkte mit UL/CSA-zugelassener Leitung

Bustechnologien

EtherNet/IP



Bauform

Bauform 44711

Leitungen	
Adernzahl/-querschnitt	2x 2x 0.34 mm ²
Aderisolation	PE (ws, ge, bl, or)
Schleppkettenwerte	3 Mio.
Mantelfarbe	grün
Material (Mantel)	PUR (UL/CSA)
Außen-Ø	6.7 mm ±5%
Biegeradius (bewegt)	12x Außen-Ø
Temperaturbereich (fest)	-40...+80 °C
Temperaturbereich (bewegt)	-30...+70 °C
Kabelkennung	796
Zulassung (Kabel)	UL (AWM-Style 20233/11602), CSA; CE
Kabelgewicht [g/m]	71
Material (Leiter)	Cu-Litze, blank
Widerstand (Leiter)	max. 55 Ω/km (20 °C)
Querschnitt (Leiter)	2x 2x AWG22
Material (Aderisolierung)	PE
Ader-Ø inkl. Isolierung	1.4 mm ±5%
Adernfarbe/Nummerierung	ws, ge, bl, or
Verseilverbund	Sternvierer, 4 Adern über zentralen Füller verseilt
Schirmung	ja
Schirmung (Art)	Kupfergeflecht
optische Schirmbedeckung	min. 85%
Material (Mantel)	PUR
Außen-Ø (Mantel)	6.7 mm ±5%
Farbe (Mantel)	grün
thermische Beständigkeit	flammwidrig
Nennspannung	300 V
Temperaturbereich (fest)	-40...+80 °C
Temperaturbereich (bewegt)	-30...+70 °C
Biegeradius (fest)	5x Außen-Ø
Biegeradius (bewegt)	12x Außen-Ø
Anzahl Biegezyklen (Schleppkette)	max. 3 Mio. (25 °C)
Verfahrweg (Schleppkette)	max. 5 m (horizontal)
Verfahrgeschwindigkeit (Schleppkette)	max. 3.3 m/s
Beschleunigung (Schleppkette)	max. 2 m/s ²
Technische Daten	
Betriebsspannung	max. 60 V DC
Betriebsspannung (nur UL-listed)	max. 30 V DC
Bemessungsstoßspannung	1.0 kV
Betriebsstrom je Kontakt	max. 1.5 A (20 °C)
Isolierstoffgruppe	IEC 60664-1, category I
Übertragungsparameter	CAT5, Class D (ISO/IEC 11801:2002), (EN 50173-1)
Übertragungsrate	bis 100 Mbit/s full duplex
Kodierung	M12, D-kodiert
Verriegelung der Steckplätze	Schraubgewinde (M12x1 mm) empf. Anzugsdrehmoment 0.6 Nm, selbstsichernd
Verschraubung	M12 (SW13)
Schutzart	IP67 (M12) - IP20 (RJ45)
Material (Verriegelung)	Zink-Druckguss, matt vernickelt

Die in diesem Datenblatt enthaltenen Angaben wurden mit der größtmöglichen Sorgfalt erarbeitet.
Für Richtigkeit, Vollständigkeit und Aktualität ist die Haftung auf grobes Verschulden begrenzt. Stand: 12/19

Material	PUR
passend für Wellenschlauch (Innen-Ø)	ohne
Allgemeine Daten	
Normen	DIN EN 61076-2-101 (M12)
Verschmutzungsgrad	3
Temperaturbereich	-25...+85 °C, abhängig von angeschlossener Leitung
Kaufmännische Daten	
EAN	4048879140898
eClass	27061801
Ursprungsland	DE
Verpackungseinheit	1
Zolltarifnummer	85444290

M12 male 0° / RJ45 male 0° shielded Ethernet

PUR 2x2xAWG22 shielded gn UL,CSA+dragch. 5m

Male straight – male straight

M12 – RJ45, 4-pole

D-coded

shielded

Ethernet CAT5

Further cable lengths on request. Plastic housings with good resistance against chemicals and oils. The resistance to aggressive media should be individually tested for your application. Further details on request.

[Link to Product](#)

Illustration

stay connected

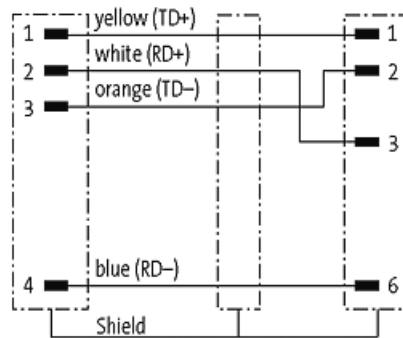
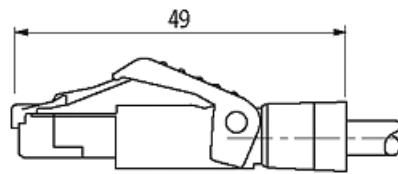
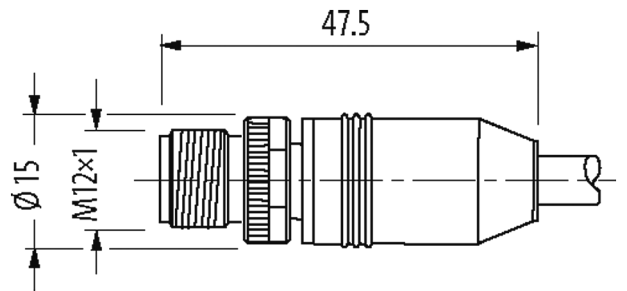

Male

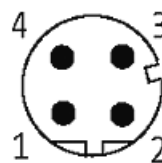

Male

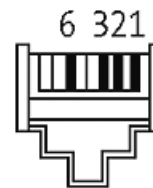

Product may differ from Image

Approvals



* only for products with UL/CSA approved cable

More Info

EtherNet/IP



Form

Form 44711

Cables	
No./diameter of wires	2 × 2 × 0.34 mm ²
Wire isolation	PE (wh, ye, bl, or)
C-track properties	3 Mio.
Jacket Color	green
Material (jacket)	PUR (UL/CSA)
Outer Ø	6.7 mm ±5%
Bend radius (moving)	12 × outer Ø
Temperature range (fixed)	-40...+80 °C
Temperature range (mobile)	-30...+70 °C
Cable identification	796
Approval (cable)	UL (AWM-Style 20233/11602), CSA; CE
Cable weight [g/m]	71
Material (wire)	Cu wire, bare
Resistor (core)	max. 55 Ω/km (20 °C)
Diameter (core)	2 × 2 × AWG22
Material (wire isolation)	PE
Wire-Ø incl. isolation	1.4 mm ±5%
Color/numbering of wires	wh, ye, bl, or
Shield	yes
	min. 85%
Material (jacket)	PUR
Outer-Ø (jacket)	6.7 mm ±5%
Color (jacket)	green
thermal resistance	flame retardant
Nominal voltage	300 V
Temperature range (fixed)	-40...+80 °C
Temperature range (mobile)	-30...+70 °C
Bend radius (fixed)	5 × outer Ø
Bend radius (moving)	12 × outer Ø
No. of bending cycles (C-track)	max. 3 Mio. (25 °C)
Traversing distance (C-track)	max. 5 m (horizontal)
Travel speed (C-track)	max. 3.3 m/s
Acceleration (C-track)	max. 2 m/s ²
Technical Data	
Operating voltage	max. 60 V DC
Operating voltage (only UL listed)	max. 30 V DC
Rated surge voltage	1.0 kV
Operating current per contact	max. 1.5 A (20 °C)
Material group	IEC 60664-1, category I
Transfer parameters	CAT5, Class D (ISO/IEC 11801:2002), (EN 50173-1)
Transfer rate	up to 100 Mbit/s full duplex
Coding	M12, D-coded
Locking of ports	Screw thread (M12×1 mm) recommended torque 0.6 Nm, self-securing
Compression gland	M12 (SW13)
Protection	IP67 (M12) - IP20 (RJ45)
Locking material	Zinc die casting, matte nickel plated
Material	PUR
suitable for corrugated tube (internal Ø)	without

General data

Standards	DIN EN 61076-2-101 (M12)
Pollution Degree	3
Temperature range	-25...+85 °C, depending on cable quality

Commercial data

country of origin	DE
customs tariff number	85444290
EAN	4048879140898
eClass	27061801
Packaging unit	1