

M12Bu.0° geschirmt B-cod,freies Ltg-ende,Profibus

PUR 1x2xAWG24 geschirmt vt UL/CSA+schleppk. 15m

PROFIBUS

Buchse gerade

M12, 2-polig

B-kodiert

geschirmt

Das Material der Gehäuse ist aus Kunststoff und hat eine gute Chemikalien- und Ölbeständigkeit. Beim Einsatz aggressiver Medien ist die Materialbeständigkeit applikationsbezogen zu überprüfen. Nähere Details auf Anfrage. Abweichende Leitungslängen auf Anfrage lieferbar.

[Link zum Produkt](#)

Abbildungen

stay connected

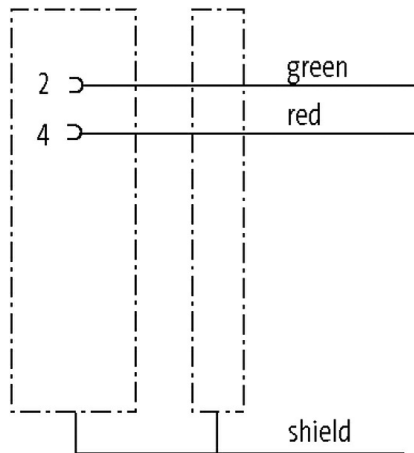
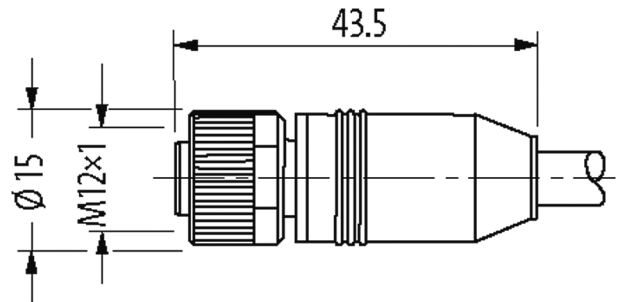
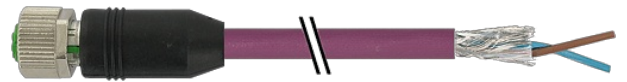

Female



Abbildung stellvertretend

Zulassungen



* nur für Produkte mit UL/CSA-zugelassener Leitung

cCSAus

Bustechnologien



Bauform

Bauform 14061

Leitungen

Adernzahl/-querschnitt	1 x 2 x 0.25 mm ²
Aderisolation	PE (rt, gn)
Schleppkettenwerte	10 Mio.
Mantelfarbe	violett
Material (Mantel)	PUR (UL/CSA)
Außen-Ø	7.8 mm ±5%
Biegeradius (bewegt)	12x Außen-Ø
Temperaturbereich (fest)	-40...+80 °C
Temperaturbereich (bewegt)	-20...+60 °C
Kabelkennung	840
Zulassung (Kabel)	UL (AWM-Style 20236/1589), CSA; CE
Kabelgewicht [g/m]	82,50
Material (Leiter)	Cu-Litze, blank
Widerstand (Leiter)	max. 78 Ω/km (20 °C)
Einzeldraht-Ø (Leiter)	0.127 mm
Aufbau (Leiter)	19 x 0.127 mm
Querschnitt (Leiter)	1 x 2 x 0.25 mm ²
AWG	ähnlich AWG 24
Material (Aderisolierung)	PE
Ader-Ø inkl. Isolierung	2.55 mm ±5%
Adernfarbe/Nummerierung	rt, gn
Verseilverbund	2 Adern verseilt
Schirmung	ja
Schirmung (Art)	Kupfergeflecht
optische Schirmbedeckung	min. 70%
Material (Mantel)	PUR
Außen-Ø (Mantel)	7.8 mm ±5%
Farbe (Mantel)	violett
chemische Beständigkeit	gute Öl-, Benzin- und Chemikalienbeständigkeit
thermische Beständigkeit	flammwidrig
Nennspannung	250 V
Temperaturbereich (fest)	-40...+80 °C
Temperaturbereich (bewegt)	-20...+60 °C
Biegeradius (fest)	10x Außen-Ø
Biegeradius (bewegt)	12x Außen-Ø
Anzahl Biegezyklen (Schleppkette)	max. 10 Mio. (25 °C)
Verfahrweg (Schleppkette)	max. 5 m (horizontal)
Verfahrgeschwindigkeit (Schleppkette)	max. 3 m/s
Beschleunigung (Schleppkette)	max. 5 m/s ²

Technische Daten

Betriebsspannung	max. 60 V AC/DC
Betriebsspannung (nur UL-listed)	max. 30 V AC/DC

Bemessungsstoßspannung	1.5 kV
Betriebsstrom je Kontakt	max. 4 A
Isolierstoffgruppe	IEC 60664-1, category I
Kodierung	B-kodiert
Verriegelung der Steckplätze	Schraubgewinde (M12×1 mm) empf. Anzugsdrehmoment 0.6 Nm, selbstsichernd
Verschraubung	M12 (SW13)
Schutzart	IP65, IP66K, IP67 in gestecktem und verschraubtem Zustand (EN 60529)
Material (Verriegelung)	Zink-Druckguss, matt vernickelt
Material	PUR

Allgemeine Daten

Normen	DIN EN 61076-2-101 (M12)
Verschmutzungsgrad	3
Abmantellänge	20 mm
Temperaturbereich	-25...+85 °C, abhängig von angeschlossener Leitung

Kaufmännische Daten

EAN	4048879198080
eClass	27061801
Ursprungsland	DE
Verpackungseinheit	1
Zolltarifnummer	85444290

M12 female 0° shielded B-cod. with cable, Profibus

PUR 1x2xAWG24 shielded vt UL/CSA+dragchain 15m

PROFIBUS
Female straight
M12, 2-pole
B-coded
shielded

Plastic housings with good resistance against chemicals and oils. The resistance to aggressive media should be individually tested for your application. Further details on request. Further cable lengths on request.

[Link to Product](#)

Illustration

stay connected

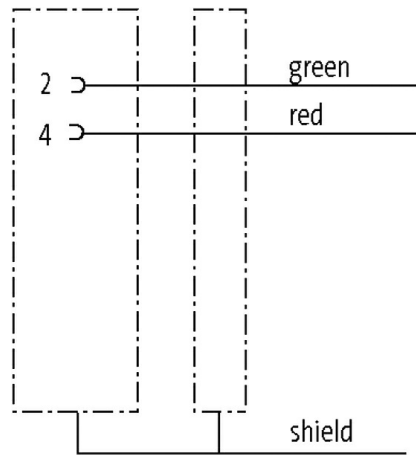
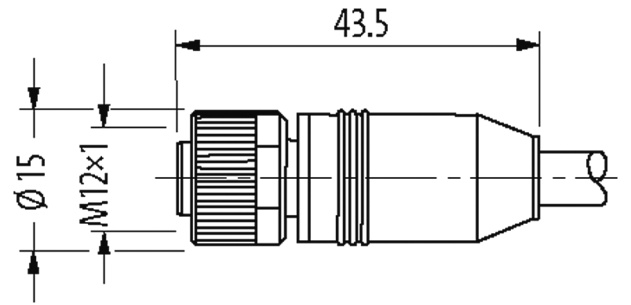

Female

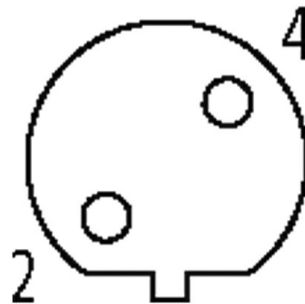

Product may differ from Image

Approvals



* only for products with UL/CSA approved cable

cCSAus

More Info



Form	
Form	14061
Cables	
No./diameter of wires	1 × 2 × 0.25 mm ²
Wire isolation	PE (rd, gn)
C-track properties	10 Mio.
Jacket Color	violet
Material (jacket)	PUR (UL/CSA)
Outer Ø	7.8 mm ±5%
Bend radius (moving)	12× outer Ø
Temperature range (fixed)	-40...+80 °C
Temperature range (mobile)	-20...+60 °C
Cable identification	840
Approval (cable)	UL (AWM-Style 20236/1589), CSA; CE
Cable weight [g/m]	82,50
Material (wire)	Cu wire, bare
Resistor (core)	max. 78 Ω/km (20 °C)
Single wire Ø (core)	0.127 mm
Construction (core)	19 × 0.127 mm
Diameter (core)	1 × 2 × 0.25 mm ²
AWG	similar to AWG 24
Material (wire isolation)	PE
Wire-Ø incl. isolation	2.55 mm ±5%
Color/numbering of wires	rd, gn
Stranding combination	2 wires twisted
Shield	yes
	min. 70%
Material (jacket)	PUR
Outer-Ø (jacket)	7.8 mm ±5%
Color (jacket)	violet
chemical resistance	good resistance to oil, gasoline and chemicals
thermal resistance	flame retardant
Nominal voltage	250 V
Temperature range (fixed)	-40...+80 °C
Temperature range (mobile)	-20...+60 °C
Bend radius (fixed)	10× outer Ø
Bend radius (moving)	12× outer Ø
No. of bending cycles (C-track)	max. 10 Mio. (25 °C)
Traversing distance (C-track)	max. 5 m (horizontal)
Travel speed (C-track)	max. 3 m/s
Acceleration (C-track)	max. 5 m/s ²
Technical Data	
Operating voltage	max. 60 V AC/DC
Operating voltage (only UL listed)	max. 30 V AC/DC
Rated surge voltage	1.5 kV
Operating current per contact	max. 4 A

Material group	IEC 60664-1, category I
Coding	B-coded
Locking of ports	Screw thread (M12×1 mm) recommended torque 0.6 Nm, self-securing
Compression gland	M12 (SW13)
Protection	IP65, IP66K, IP67 inserted and tightened (EN 60529)
Locking material	Zinc die casting, matte nickel plated
Material	PUR

General data

Standards	DIN EN 61076-2-101 (M12)
Pollution Degree	3
Stripping length (jacket)	20 mm
Temperature range	-25...+85 °C, depending on cable quality

Commercial data

country of origin	DE
customs tariff number	85444290
EAN	4048879198080
eClass	27061801
Packaging unit	1